

# WeldTec®



## Micro TIG Welding Torches

WeldTec® offers the most advanced micro welding TIG torches on the market . . . and now, flexible\* neck models, both air cooled and water cooled.

When the WeldTec® design team introduced the micro torch to the market 25 years ago it first appeared as a 50 amp air cooled model. To meet the needs of today's welding challenges they reintroduce two new models, a 125 amp water cooled model and a 60 amp air cooled model. Both models share chucks and clear glass nozzles. They can be fitted with 45°, 90°, 180° or 45°/90° combo chucks (.040, 1/16) and clear glass nozzles to handle the most difficult welding applications.

The standard torch neck length is 3-1/2 inches, the flexible neck model is 5 inches long. The standard non-flex models can be special made with a neck length as short as 2 inches to as long as 12 inches.

Access to difficult weld locations was never easier.

- Low profile design for access to tight locations.
- Flexible neck models.
- Interchangeable chucks and nozzles.
- Clear glass nozzles for better visibility.
- Low maintenance dual o-ring head design.
- Flexible - soft rubber hose and power cable options.
- Glove soft leather protective cable cover on DX models.



Standard  
3 1/2"

Flex Neck  
5"

Specials  
2" - 12"

WT-60-12	12 1/2 ft. Torch Package - Vinyl	Standard Model	60 Amps Air Cooled
WT-60-25	25 ft. Torch Package - Vinyl		
WT-60-12SF	12 1/2 ft. Torch Package - Super Flex	Flex Neck Model	60 Amps Air Cooled
WT-60-25SF	25 ft. Torch Package - Super Flex		
WT-60F-12	12 1/2 ft. Torch Package - Vinyl	Flex Neck Model	60 Amps Air Cooled
WT-60F-25	25 ft. Torch Package - Vinyl		
WT-60F-12SF	12 1/2 ft. Torch Package - Super Flex	Flex Neck Model	60 Amps Air Cooled
WT-60F-25SF	25 ft. Torch Package - Super Flex		
WT-125-12	12 1/2 ft. Torch Package - Vinyl	Standard Model	125 Amps Water Cooled
WT-125-25	25 ft. Torch Package - Vinyl		
WT-125-12R	12 1/2 ft. Torch Package - Super Flex	Standard Model	125 Amps Water Cooled
WT-125-25R	25 ft. Torch Package - Super Flex		
WT-125-12DX	12 1/2 ft. Torch Package - Deluxe	Standard Model	125 Amps Water Cooled
WT-125-25DX	25 ft. Torch Package - Deluxe		
WT-125F-12	12 1/2 ft. Torch Package - Vinyl	Flex Neck Model	125 Amps Water Cooled
WT-125F-25	25 ft. Torch Package - Vinyl		
WT-125F-12R	12 1/2 ft. Torch Package - Super Flex	Flex Neck Model	125 Amps Water Cooled
WT-125F-25R	25 ft. Torch Package - Super Flex		
WT-125F-12DX	12 1/2 ft. Torch Package - Deluxe	Flex Neck Model	125 Amps Water Cooled
WT-125F-25DX	25 ft. Torch Package - Deluxe		

Standard: Vinyl - PVC plastic tubing.

Optional: Super Flex - soft over braided rubber tubing.

Deluxe: Soft over braided rubber tubing, leather cover, 1/16 combo chuck and 45 deg. nozzle.



WeldTec® - "where quality and innovation never ends"

Specifications subject to change without notice. \*Flex neck models have a finite life and will work harden and fail after extensive or server flexing.



## MICRO TIG TORCHES

WT-60, 60F, 125, 125F

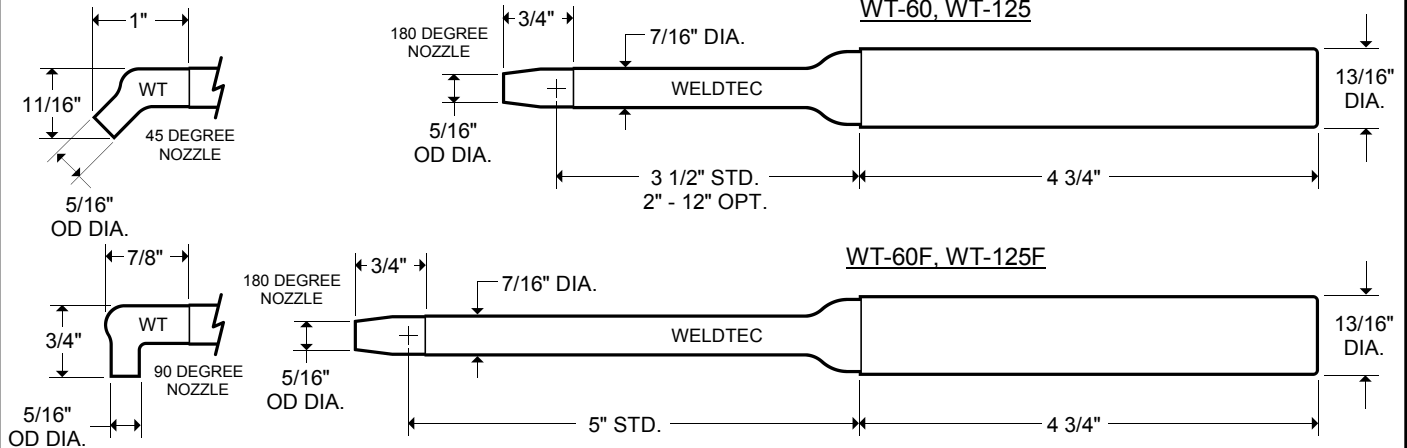

### SPECIFICATIONS

Maximum Amperage Capacity  
Tungsten Size Capacity  
Cooling Requirements  
Maximum Coolant Pressure

### WT-60, 60F

60 AMPS  
.040 - 1/16 (1,0 - 1,6)  
-  
-

### WT-125, 125F

125 AMPS  
.040 - 3/32 (1,0 - 2,4)  
1 Qt./Min. (.964L/Min.)  
50 psi (345 Kpa)

### TUNGSTEN ELECTRODE LENGTHS

Angle	Std.		Min.		Max.	
	In.	mm	In.	mm	In.	mm
90°	.866	22	.787	20	.866	22
45°	.866	22	.866	22	.945	24
180°	.866	22	.748	19	1.182	30

### GLASS NOZZLES

TORCH	LENGTH	ORIFICE IN	mm	SIZE	PART NO.
WT-60, 60F, 125, 125F	1"	1/4	6	4	125N45
WT-60, 60F, 125, 125F	7/8"	1/4	6	4	125N90
WT-60, 60F, 125, 125F	3/4"	1/4	6	4	125N180

### CHUCKS

TORCH	ELECTRODE ANGLE	SIZE IN	mm	PART NO.
WT-60, 60F, 125, 125F	45 & 90 deg. Combo	.040	1,0	125C40C
		1/16	1,6	125C116C
	45 deg. Chuck	3/32	2,4	125C332-45
WT-60, 60F, 125, 125F	90 deg. Chuck	3/32	2,4	125C332-90
		.020	0,5	125C20
	180 deg. Straight	.040	1,0	125C40
		1/16	1,6	125C116
		3/32	2,4	125C332

### REPLACEMENT PARTS

TORCH	DESCRIPTION	PART NO.
	Torch Body	WT-60
	Torch Body	WT-60F
	Handle	H-100
	Torch Body	WT-125
	Torch Body	WT-125F
	Handle	H-100B
WT-60, 60F, 125, 125F	Chuck Wrench (Use with 180 deg. chuck)	53N20
WT-60, 60F, 125, 125F	Torch Body O-Ring (2 Required) (Included on torch body)	98W77

### POWER CABLE ADAPTERS

ADAPTERS	TORCH	PART NO.
	WT-60, 60F	105Z57
	WT-125, 125F	45V11
DINSE CONNECTORS	WT-60, 60F	3538 3538GT
	WT-125, 125F	3578W 3578W-GT

### ACCESSORY KITS

TORCH	DESCRIPTION	PART NO.
WT-60, 60F	Accessory Kit - .040 Parts	AK-60
WT-125, 125F	Accessory Kit - 1/16 Parts	AK-125

Note: Specifications and dimensions are subject to change without notice.

## REPLACEMENT PARTS

### WT-60 • WT-60F

STANDARD FLEX NECK  
60 AMPS • AIR COOLED

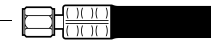
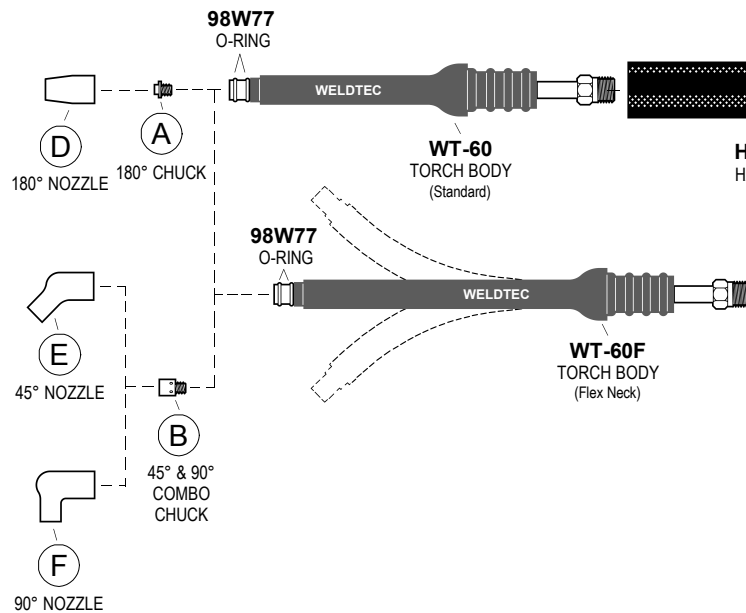
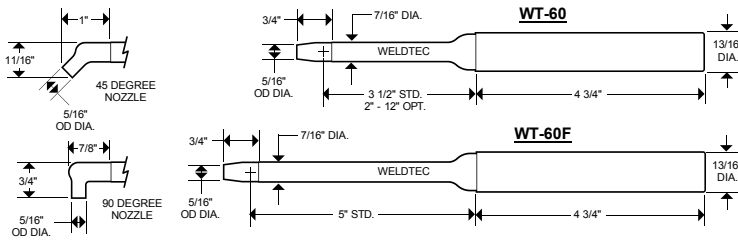

**57Y11 12.5 FT.**  
**57Y13 25 FT.**  
POWER CABLE - VINYL



**57Y11SF 12.5 FT.**  
**57Y13SF 25 FT.**  
"SF" POWER CABLE - SUPER FLEX



**53N20**  
CHUCK WRENCH  
(Use With 180° Chuck)

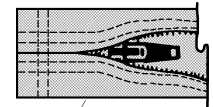

**TCL-3-10Z 11 FT.**  
**TCL-3-22Z 24 FT.**  
3" LEATHER CABLE COVER  
WITH ZIPPER CLOSURE  
(See Cable Covers For Options)

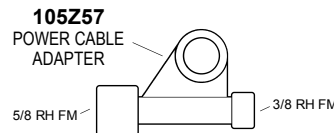

**105Z57**  
POWER CABLE  
ADAPTER

**QUICK CONNECTOR**  
(See Quick Connector Guide)

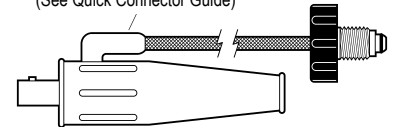

COPYRIGHT 2007 - 2015 TEC WELDING PRODUCTS, INC.

**AK-60 ACCESSORY KIT - .040**  
INCLUDES: 1 - 45° & 90° COMBO CHUCK .040  
1 - 180° CHUCK .040  
1 - 45° GLASS NOZZLE #4  
1 - 90° GLASS NOZZLE #4  
1 - 180° GLASS NOZZLE #4  
1 - CHUCK WRENCH  
1 - TUNGSTEN ELECTRODE .040  
1 - PARTS STORAGE BOX

**AK-125 ACCESSORY KIT - 1/16**  
INCLUDES: 1 - 45° & 90° COMBO CHUCK 1/16  
1 - 180° CHUCK 1/16  
1 - 45° GLASS NOZZLE #4  
1 - 90° GLASS NOZZLE #4  
1 - 180° GLASS NOZZLE #4  
1 - CHUCK WRENCH  
1 - TUNGSTEN ELECTRODE 1/16  
1 - PARTS STORAGE BOX

### CHUCKS

ITEM	ELECTRODE DIAMETER	.020		1/16	
		0,5	1,0	1,6	1,6
A	180° CHUCK	125C20	125C40	125C116	
B	45° & 90° CHUCK	—	125C40C	125C116C	

### GAS NOZZLES

ITEM	NO. SIZE	4 1/4"
D	180° GLASS NOZZLE	125N180
E	45° GLASS NOZZLE	125N45
F	90° GLASS NOZZLE	125N90

### TORCH PACKAGES

PART NUMBER	DESCRIPTION	
<b>WT-60-12</b>	12 1/2 ft. Torch Package - Vinyl	Standard Model
<b>WT-60-25</b>	25 ft. Torch Package - Vinyl	
<b>WT-60-12SF</b>	12 1/2 ft. Torch Package - Super Flex	Standard Model
<b>WT-60-25SF</b>	25 ft. Torch Package - Super Flex	
<b>WT-60F-12</b>	12 1/2 ft. Torch Package - Vinyl	Flex Neck Model
<b>WT-60F-25</b>	25 ft. Torch Package - Vinyl	
<b>WT-60F-12SF</b>	12 1/2 ft. Torch Package - Super Flex	Flex Neck Model
<b>WT-60F-25SF</b>	25 ft. Torch Package - Super Flex	

### TUNGSTEN ELECTRODE LENGTHS

Angle	Std.		Min.		Max.	
	In.	mm	In.	mm	In.	mm
90°	.866	22	.787	20	.866	22
45°	.866	22	.866	22	.945	24
180°	.866	22	.748	19	1.182	30

Specifications and descriptions subject to change without notice.